

# Hob induction FMA 804 I F BK | 108.0606.112

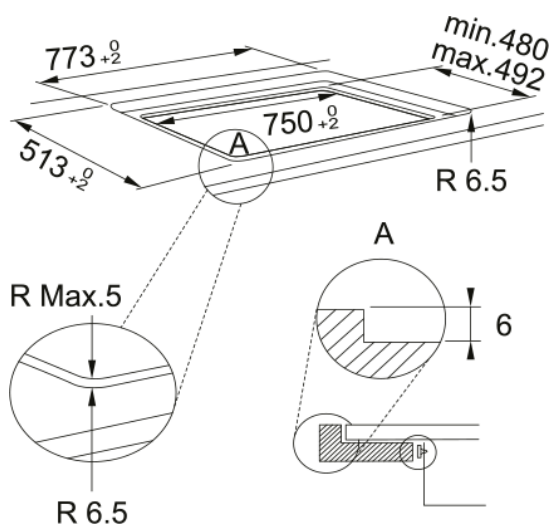
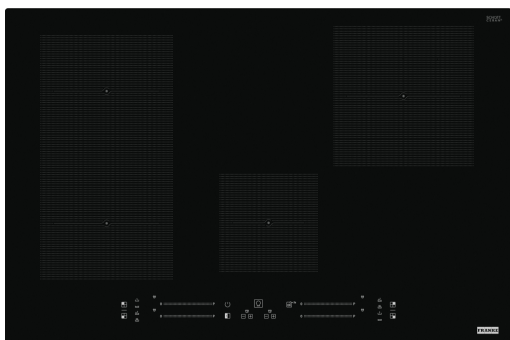

Hob induction FMA 804 I F BK

## Product Information

Type	Electric
Technology	Induction vitroceramic
Color	Black
Finish	Glass
Power limitation	yes

## Dimensions

Commercial dimension	75x50
Width overall	770.0
Cutout Depth	490.0
Cutout width	750.0
Packaging Depth	600.0
Packaging Width	855.0

## Energy specifications

MAX booster nominal power (W)	3000.0
Total power (kW)	7.2
Voltage	220-240 V
Frequency (Hz)	50-60

## Product specifications

Installation type hob	Standard&flush
Bridge zone	No
Flexi zone	Yes
Safety lock	Yes
Cookassist	Boiling
Cookassist	Keep warm
Cookassist	Melting
Cookassist	Simmering
Frame shape	Frameless

Glass dimension (mm)	770x510
Hob/hood connection	no
Power cord length	1200.0
Power management (kW)	2.5 - 4.0 - 6.0 - 7.2
Digit color	Red
Supply cord	Yes
B.power of h.zone front left(W)	2200
Diam. of h.zone front left(mm)	200/170
Power of h.zone front left (W)	1750
B.pow. of h.zone front right(W)	1600
Diam. of h.zone front right(mm)	145
Power of h.zone front right (W)	1200
B.power of h.zone rear left(W)	2200
Diam. of h.zone rear left(mm)	200/170
Power of h.zone rear left (W)	1750
B.power of h.zone rear right(W)	3000
Diam. of h.zone rear right(mm)	210
Power of h.zone rear right (W)	2100
<b>Product identification</b>	
Product brand	FRANKE
Product family	Maris
Model range	MARIS
<b>Properties</b>	
Technical UI Type	Touch control
Number of heating zone	4
Type of heat. zone front left	Square
Type of heating zone rear left	Square
Type of heating zone rear right	Rounded
Type of heat. zone front right	Rounded
User interface	Direct touch buttons&sliders
Number of slider	4
Timer	Yes
Dual zone	No
Oval zone	NO
FlexPro zone	no
Power level	18 + booster
Number of booster	4