

Food waste disposer Slim 50 CN | 134.0721.210

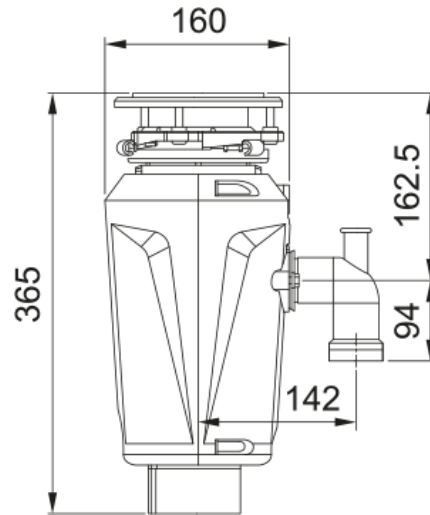

Food waste disposer Slim 50, motor 0.50 HP, 2600 rpm, continuous feed, insulated shell, vibrant red, matt finish, integrated airswitch connection, air control button included, cord included, 220V for Asia

Product Information

Product type Food waste disposer

Energy specifications

Voltage 220-240 V

Product identification

Product brand FRANKE

Product family Mythos

Model range Elite Slimline

Properties

Horse power waste disposer 1/2 HP

Motor speed 2600.0

Waste disposer motor type Permanent magnet

Feed type Continuous