



The all-round performer



READY FOR
DIGITAL SERVICES

Colors

- Black/chrome
- Anthracite/chrome

1 A600 Options

- First shot
- Second bean grinder
- Bean hopper: 1×2 kg, 2×1.2 kg or 2×0.6 kg, lockable
- One or two separate powder dosing systems 0.6 kg or 1.2 kg (for chocolate or milk powder), lockable
- Coffee grounds chute assembly
- Cup sensor
- Raised feet (100 mm)
- Steam spout (S1), Autosteam (S2) (enhanced milk foaming) or Autosteam Pro (S3) (automatic milk foaming)
- Second milk type (only with the SU12)
- DualMilk Technology for low cross contamination (only with SU12 and all-in-one spout)

2 Milk Systems

- FoamMaster™ (FM): hot and cold milk and milk foam, individually adjustable consistency, integrated cleaning system
- Milk system (MS): hot and cold milk and warm milk foam, exact dosing via milk pump

2 Cleaning Systems

- CleanMaster (CM): fully automatic cleaning system with integrated cleaning cartridge. For outstanding hygiene and unbeatable simplicity, efficiency, and convenience
- EasyClean (EC): automatic cleaning system with manual addition of the cleaning fluid. Perfect hygiene in just a few steps

3 Flavor Station

- Automatic dosing station for up to three flavors

4 Accounting System

- Can be used for various payment methods, e.g. with coins, card
- Ideally suited to public/private vending applications

5 Cup warmer

- With four heatable trays

Flexibility

Our product portfolio allows various assembly options — tailored to your needs.



FRANKE

Franke Kaffeemaschinen AG
cs-info.ch@franke.com

Franke Coffee Systems GmbH
cs-info.de@franke.com

Franke Coffee Systems Americas
cs-coffeesales.us@franke.com

Franke Coffee Systems UK
sales@frankecoffeesystems.co.uk

coffee.franke.com

FRANKE

A600



Expand your coffee business with the A600, our superior solution for served and self-service operations. Equipped with state-of-the-art yet easy-to-use technologies, the A600 is our versatile and intelligent all-rounder. This fully automatic coffee machine offers consistently high in-cup quality and gives you and your customers full control over the preparation of the finest coffee specialties - at the touch of a button.

Choose the A600 to bring unique coffee moments to large groups of guests with a wide choice of premium beverages.

CAPACITY*	SINGLE	PARALLEL
Espresso	150	194
Cappuccino	98	160
Coffee	100	121
Hot water	164	

*Cups per hour according to DIN 18873

CleanMaster
Fully automatic
cleaning process meeting
highest hygiene standards

Touch Screen
Practical 8-inch touch screen
for simple, easy operation

FoamMaster™
For perfect foam,
every time

590.0690.068/09.23/CH-EN/Subject to dimensional, design and version changes.

Technical Data

Machine Models

Model	Power
A600	220–240V 1LNPE 50/60 Hz 2.4–2.8 kW (13/15/16* A)
A600 MS EC	220V 1LNPE 50 Hz 2.4 kW (16 A)
A600 FM EC	200–240V 1LNPE 50/60 Hz 2.4–2.8 kW (13/15/16* A)
	380–415 V 3LNPE 50/60 Hz 6.3–7.5 kW (16 A)
	220–240V 1LNPE 50/60 Hz 4.4–5.0 kW (30 A)
	220–240V 3LPE 50/60 Hz 5.6–7.9 kW (30 A)
	200V 2LPE 50/60 Hz 2.0 kW (15 A)
	200V 2LPE 50/60 Hz 4.5 kW (30 A)
	200V 3LPE 50/60 Hz 6.8 kW (30 A)
	220V 1LNPE 50 Hz 2.4 kW (16 A)
	380V 3LNPE 50 Hz 6.3 kW (16 A)
	200–220V 2LPE 60 Hz 4.5–5.3 kW (30 A)
Dimensions	340 mm / 750 mm / 600 mm (W/H/D)
Weight (empty)	approx. 38 kg

A600 FM CM	220–220V 2LPE 60 Hz 4.5–5.3 kW (30 A)
	230V 1LNPE 50/60 Hz 2.1–2.3 kW (10 A)
	200V 2LPE 50/60 Hz 2.0 kW (15 A)
SU05 CM	220-240 VAC, 1L N PE, 1950-2300 W, 50-60 Hz, 10 A (EU)
	120 VAC, 1L PE, 1400 W, 60 Hz, 15 A (USA)
Dimensions	340 mm / 613 mm / 560 mm (W/H/D) (FM CM incl. SU05 CM)
Weight (empty)	approx. 64 kg (FM CM incl. SU05 CM)
Colors	Black or anthracite

Water connection

Mains water connection	Metal hose with union nut G3/8", L = 1500 mm
Water supply line	If possible on installation side: untreated water of drinking water quality (not from household decalcification system)
Water pressure	80–800 kPa (0.8–8.0 bar)
Flowrate	> 0.1l/sec
Water temperature	< 25°C
Total hardness	4–8°dH GH (German total hardness) / 7–14°fH GH (French total hardness) / 70–140 ppm (mg/l)
Carbonate hardness	3–6°dH KH (carbonate hardness) / 50–105 ppm (mg/l)
Acid content/pH value	6.5–7.5 pH
Chlorine content	< 0.5 mg/l

Internal Water Tank	Only available for A600 without MS/FM milk system or A600 MS EC with KE200, SU05 connection Built-in water tank: 4.0 liters, level monitoring with filter cartridge Claris Drip tray 3.0 liters, level monitoring
---------------------	---

Water drain

Drain hose	Dia. = 16 mm, L = 2000 mm
------------	---------------------------

ADD-ON UNITS

1 Cooling unit	SU05 EC (5 I)
Electrical connection	220–240V 1LNPE 50/60 Hz 0.72 A (10 A)
	120V 1LNPE 60 Hz 1.5 A (10 A)
	220V 1LNPE 50 Hz 0.72 A (10 A)
	100V 1LNPE 50/60 Hz 1.65 A (10 A)
Dimensions	270 mm / 540 mm / 475 mm (W/H/D)
Weight (empty)	approx. 20 kg
Compatible with	Model A600 MS EC / A600 FM EC
Colors	Black or anthracite

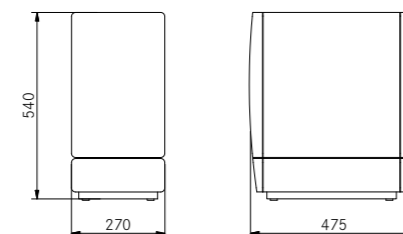
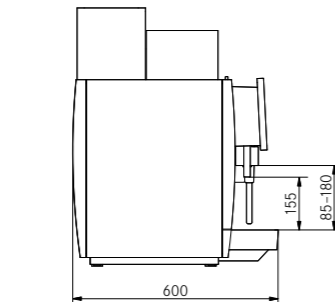
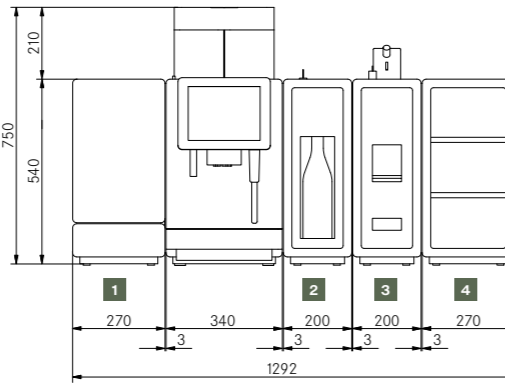

Add-on units

1 Cooling unit	SU05 CM (5 I)
Electrical connection	220–240V 1LNPE 50/60 Hz 1.95–2.3 kW (10 A)
	120V 1LNPE 60 Hz 1.44 kW (15 A)
	220V 1LNPE 50 Hz 0.72 A (10 A)
	100V 1LNPE 50/60 Hz 1.35 kW (15 A)
Dimensions	270 mm / 540 mm / 475 mm (W/H/D)
Weight (empty)	approx. 24 kg
Compatible with	Model A600 FM CM
Colors	Black or anthracite

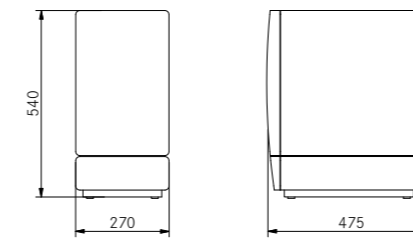

Cooling unit	SU12 EC (12 I)
Electrical connection	220–240 V 1LNPE 50/60 Hz 0.72 A (10 A)
	110–127 V 1LNPE 60 Hz 1.5–1.7 A (10 A)
	220 V 1LNPE 50 Hz 0.72 A (10 A)
	100 V 1LNPE 50/60 Hz 1.7 A (10 A)
Dimensions	340 mm / 540 mm / 475 mm (W / H / D)
Weight (empty)	approx. 26 kg
Compatible with	Model A600 MS EC / A600 FM EC
Colors	Black or anthracite

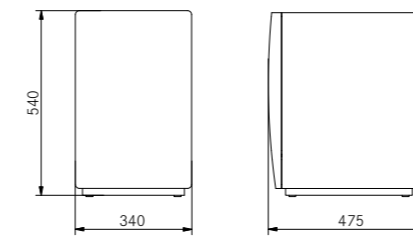

Cooling unit	KE200 EC (4 I)
Electrical connection	220–240 VAC, 1L N PE, 82 W, 10 A, 50–60 Hz
	110 VAC, 1L N PE, 1.5 A, 60 Hz
	100 VAC, 1L N PE, 1.5 A, 50–60 Hz
	225 mm / 507 mm / 453 mm (W/H/D)
Dimensions	approx. 13 kg
Weight (empty)	Model A600 MS EC / A600 FM EC
Compatible with	Stainless steel
Color	

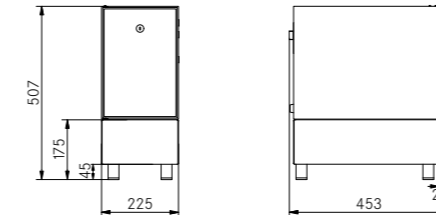

Cooling unit	UC09 EC (9 I) (Only with fix water connection available)
Electrical connection	220–240V 1LNPE 50/60 Hz (10 A)
Dimensions	330 mm / 240 mm / 550 mm (W/H/D)
Weight (empty)	approx. 27 kg
Compatible with	Model A600 MS EC (without built in water tank) / A600 FM EC
Color	Black

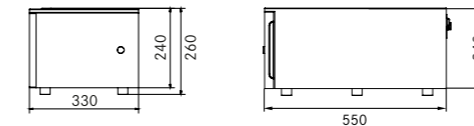

Add-on units

2 Flavor Station	FS30
Electrical connection	100–240V 1LNPE 50/60 Hz 75 W (10 A)
Dimensions	200 mm / 540 mm / 453 mm (W/H/D)
Weight (empty)	approx. 18 kg
Compatible with	Model A600 FM CM / A600 FM EC
Colors	Black or anthracite

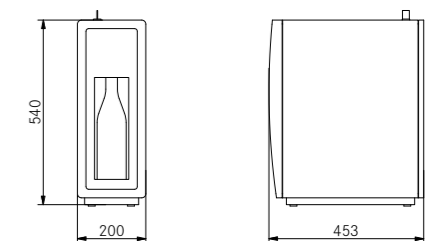

Flavor Station	FSU30
Electrical connection	220–240 V, 1L N PE, 50 W, 50–60 Hz
Dimensions	235 mm / 415 mm / 350 mm (W/H/D)
Weight (empty)	approx. 15 kg
Compatible with	Model A600 FM CM, A600 FM EC
Colors	Stainless steel

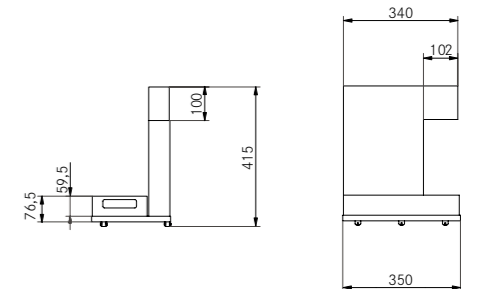

3 Accounting system	AC200
Accounting systems	Coin validator, Coin changer, Cashless system
Electrical connection	85–264 V 1LNPE 50/60 Hz (10 A)
Dimensions	200 mm / 630 mm / 453 mm (W / H / D)
Weight (empty)	approx. 18 kg
Compatible with	Model A600 / A600 MS EC / A600 FM EC / A600 FM CM
Colors	Black or anthracite

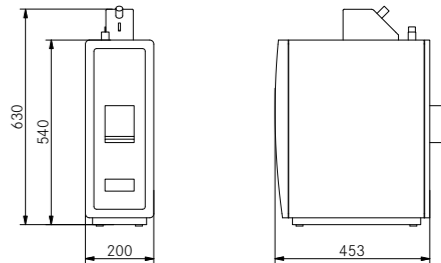

Accounting system	AC125 CL
Electrical connection	85–264V 1LNPE 50/60 Hz (10A)
Dimensions	125 mm / 150 mm / 310 mm (W / H / D)
Weight (empty)	approx. 2 kg
Compatible with	Model A600 / A600 MS EC / A600 FM EC / A600 FM CM
Colors	Black

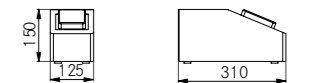

4 Cup warmer	CW
Electrical connection	220–240 VAC, 1L N PE, 110–130W, 50–60 Hz
	110–127 VAC, 1L N PE, 80–130W, 50–60 Hz
	100 VAC, 1L N PE, 80W, 50–60 Hz
	220 VAC, 1L N PE, 110W, 50–60 Hz
	270 mm / 540 mm / 454 mm (W / H / D)
Dimensions	approx. 20 kg
Weight (empty)	Model A600 / A600 MS EC / A600 FM EC / A600 FM CM
Compatible with	Black or anthracite
Colors	

