

DF

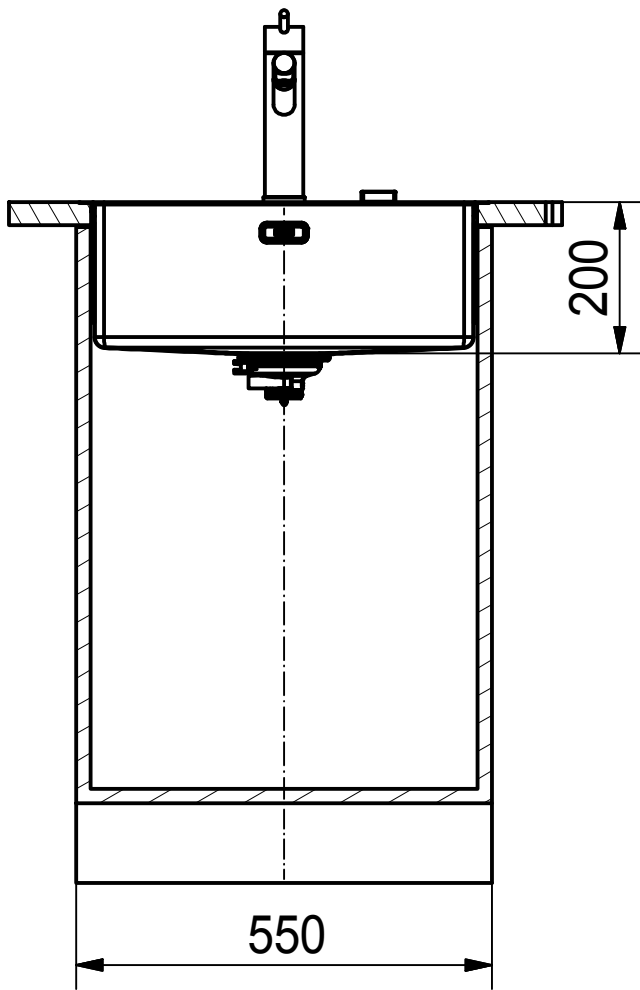

Drawing No.	20119927	Revision	B
Drawn Date	20.03.2015		
<small>These drawings and specifications are the property of Franke Technology and Trademark Ltd. and shall not be reproduced, copied or transferred to any third party without the prior written permission of Franke Technology and Trademark Ltd., Hergiswil, Switzerland</small>			

Franke Küchentechnik AG
CH-4663 Aarburg
Phone: +41 62 787 31 31
Internet: www.franke.com

BXX 210_110 50
Installing document

Sheet	Sheets
1	11

DS

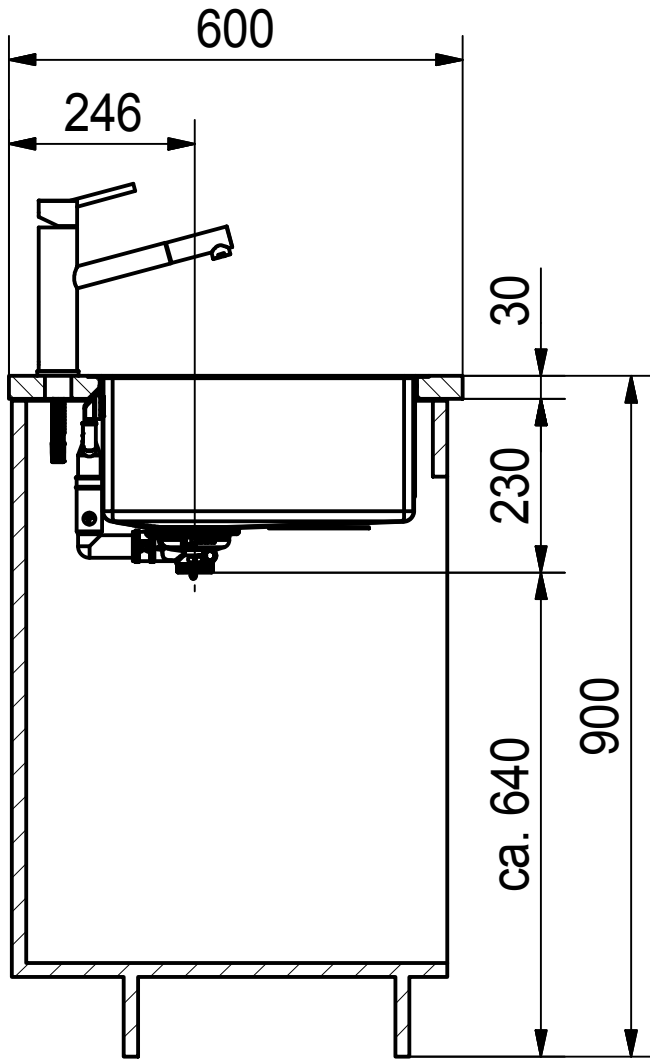

Drawing No.	20119927	Revision	B
Drawn Date	20.03.2015		
<small>These drawings and specifications are the property of Franke Technology and Trademark Ltd. and shall not be reproduced, copied or transferred to any third party without the prior written permission of Franke Technology and Trademark Ltd., Hergiswil, Switzerland</small>			

Franke Küchentechnik AG
CH-4663 Aarburg
Phone: +41 62 787 31 31
Internet: www.franke.com

BXX 210_110 50
Installing document

Sheet	Sheets
2	11

CO

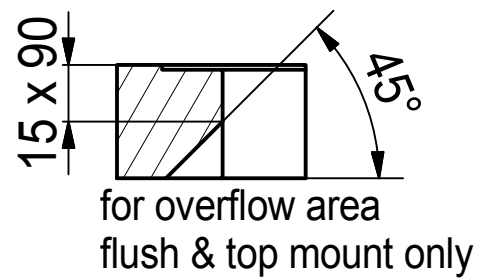
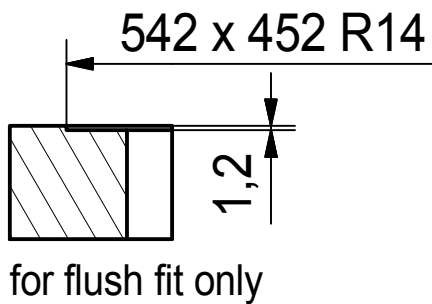
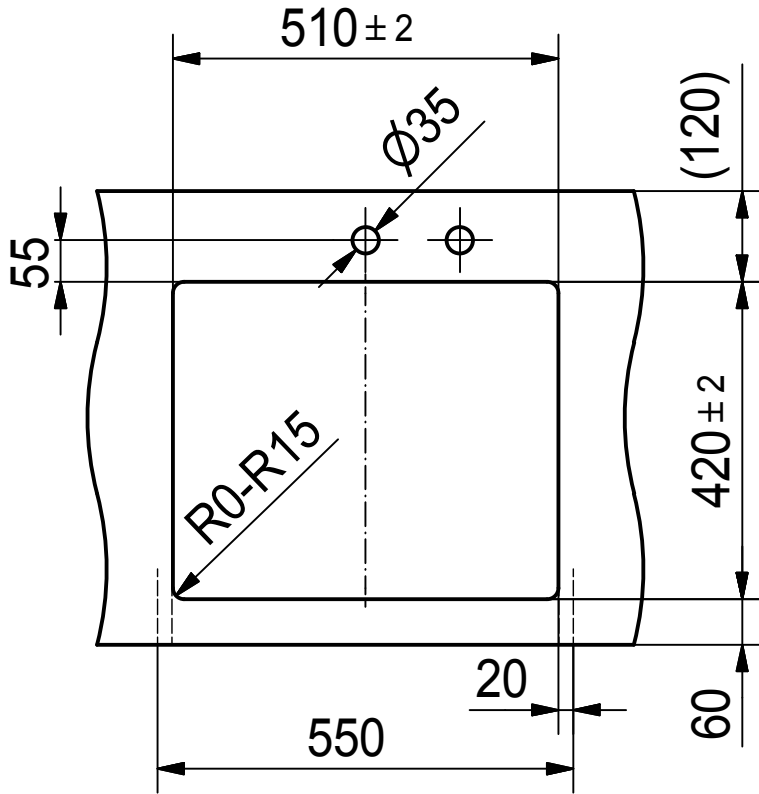

Drawing No.	20119927	Revision	B
Drawn Date	20.03.2015		
<small>These drawings and specifications are the property of Franke Technology and Trademark Ltd. and shall not be reproduced, copied or transferred to any third party without the prior written permission of Franke Technology and Trademark Ltd., Hergiswil, Switzerland</small>			

Franke Küchentechnik AG
CH-4663 Aarburg
Phone: +41 62 787 31 31
Internet: www.franke.com

BXX 210_110 50
Installing document

Sheet	Sheets
3	11

CNC



Drawing No.	20119927	Revision	B
Drawn Date	20.03.2015		
<small>These drawings and specifications are the property of Franke Technology and Trademark Ltd. and shall not be reproduced, copied or transferred to any third party without the prior written permission of Franke Technology and Trademark Ltd., Hergiswil, Switzerland</small>			

Franke Küchentechnik AG
CH-4663 Aarburg
Phone: +41 62 787 31 31
Internet: www.franke.com

BXX 210_110 50
Installing document

Sheet	Sheets
4	11

DT

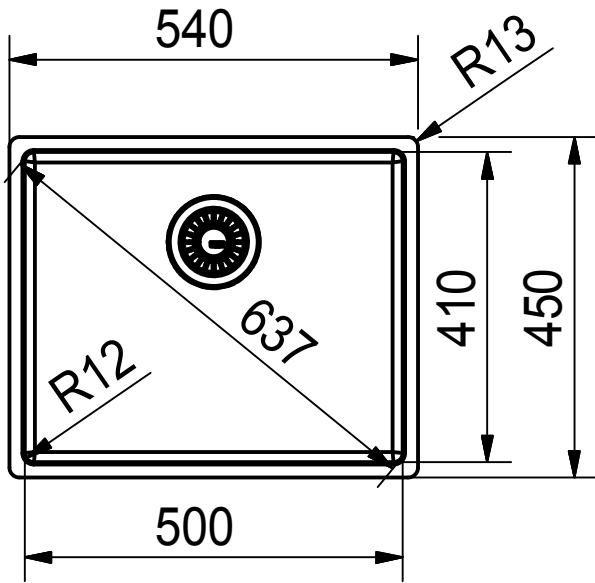

Drawing No.	20119927	Revision	B
Drawn Date	20.03.2015		
<small>These drawings and specifications are the property of Franke Technology and Trademark Ltd. and shall not be reproduced, copied or transferred to any third party without the prior written permission of Franke Technology and Trademark Ltd., Hergiswil, Switzerland</small>			

Franke Küchentechnik AG
CH-4663 Aarburg
Phone: +41 62 787 31 31
Internet: www.franke.com

BXX 210_110 50
Installing document

Sheet	Sheets
5	11

ISO

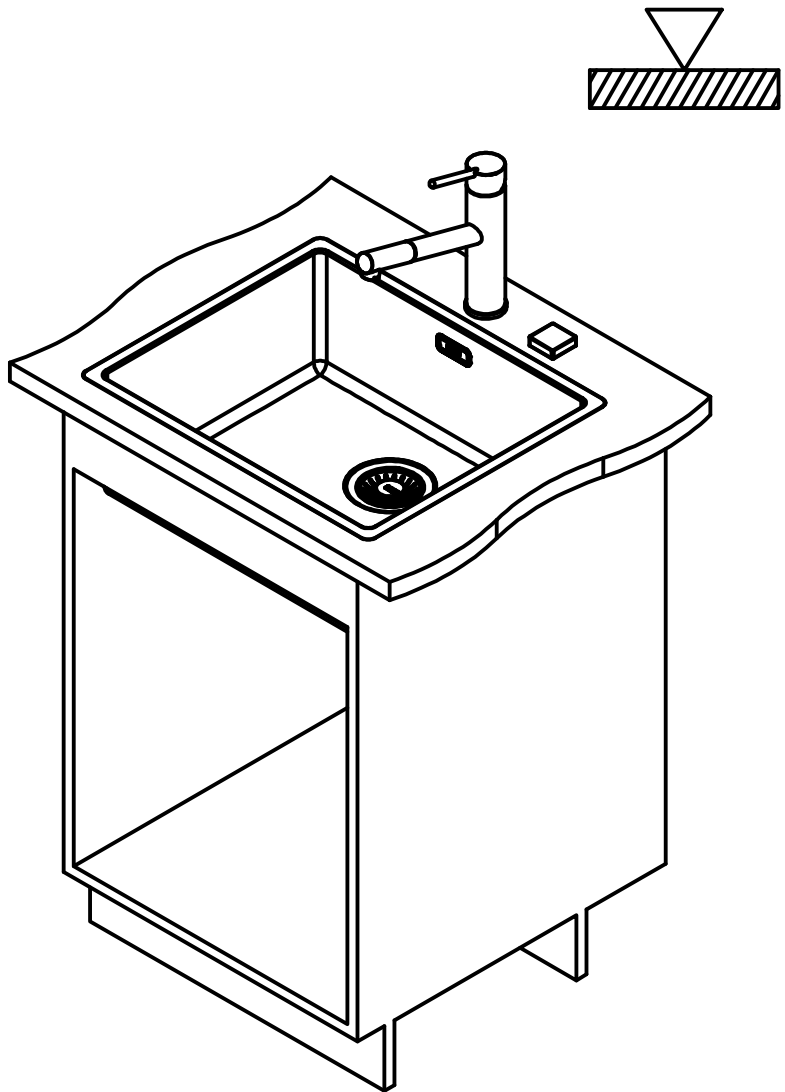

Drawing No.	20119927	Revision	B
Drawn Date	20.03.2015		
<small>These drawings and specifications are the property of Franke Technology and Trademark Ltd. and shall not be reproduced, copied or transferred to any third party without the prior written permission of Franke Technology and Trademark Ltd., Hergiswil, Switzerland</small>			

Franke Küchentechnik AG
CH-4663 Aarburg
Phone: +41 62 787 31 31
Internet: www.franke.com

BXX 210_110 50
Installing document

Sheet	Sheets
6	11

DF

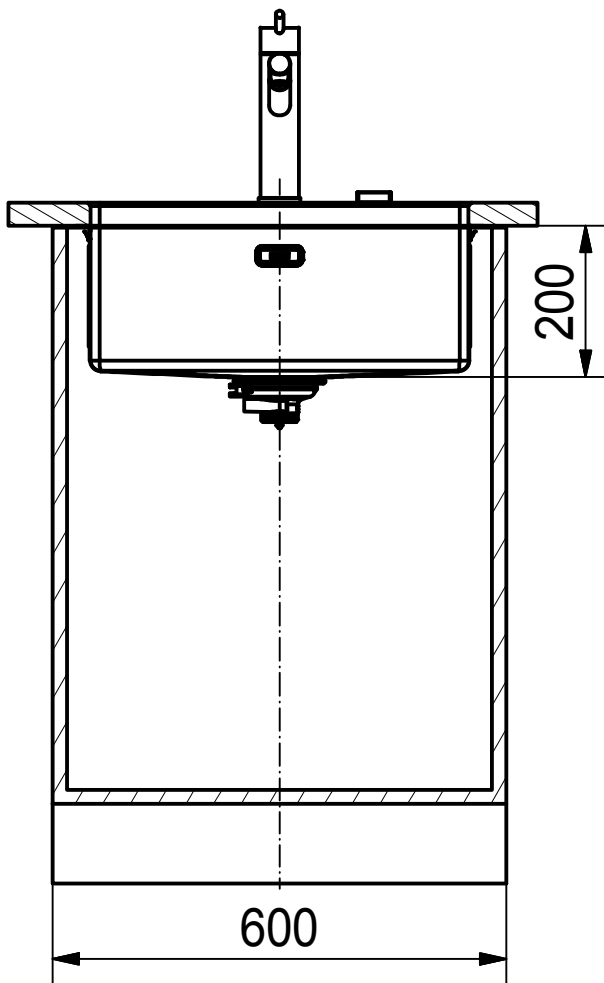

Drawing No.	20119927	Revision	B
Drawn Date	20.03.2015		
<small>These drawings and specifications are the property of Franke Technology and Trademark Ltd. and shall not be reproduced, copied or transferred to any third party without the prior written permission of Franke Technology and Trademark Ltd., Hergiswil, Switzerland</small>			

Franke Küchentechnik AG
CH-4663 Aarburg
Phone: +41 62 787 31 31
Internet: www.franke.com

BXX 210_110 50
Installing document

Sheet	Sheets
7	11

DS

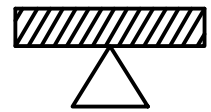
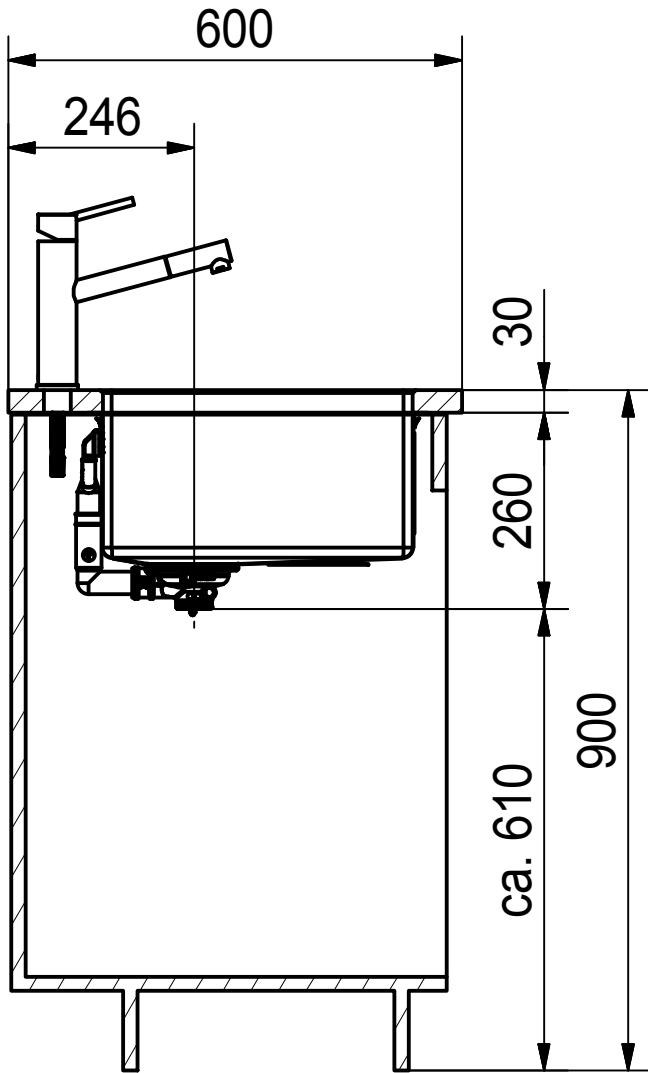

Drawing No.	20119927	Revision	B
Drawn Date	20.03.2015		
<small>These drawings and specifications are the property of Franke Technology and Trademark Ltd. and shall not be reproduced, copied or transferred to any third party without the prior written permission of Franke Technology and Trademark Ltd., Hergiswil, Switzerland</small>			

Franke Küchentechnik AG
CH-4663 Aarburg
Phone: +41 62 787 31 31
Internet: www.franke.com

BXX 210_110 50
Installing document

Sheet	Sheets
8	11

CO

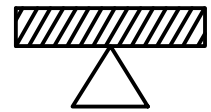
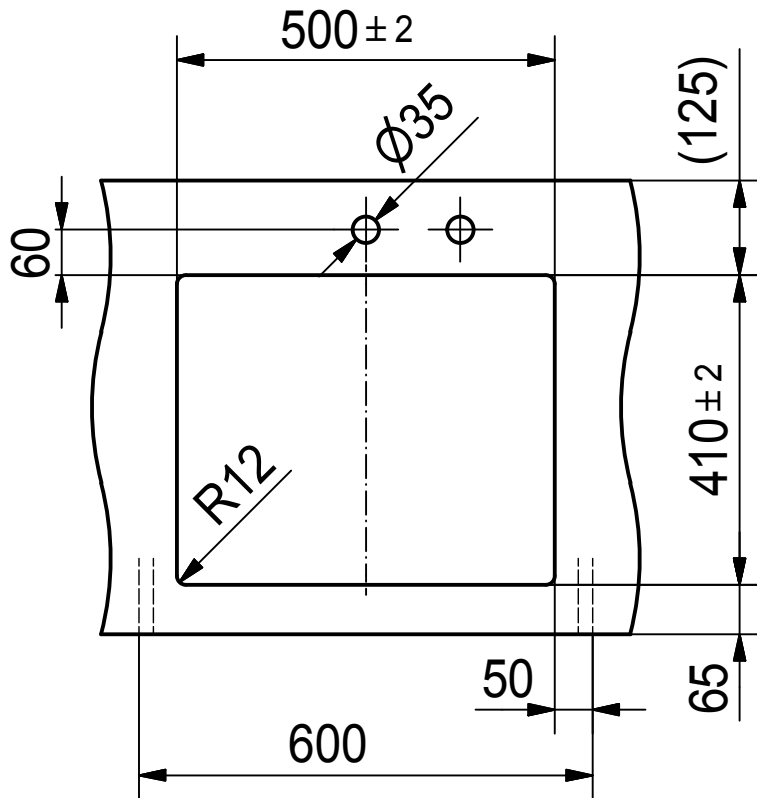

Drawing No.	20119927	Revision	B
Drawn Date	20.03.2015		
<small>These drawings and specifications are the property of Franke Technology and Trademark Ltd. and shall not be reproduced, copied or transferred to any third party without the prior written permission of Franke Technology and Trademark Ltd., Hergiswil, Switzerland</small>			

Franke Küchentechnik AG
CH-4663 Aarburg
Phone: +41 62 787 31 31
Internet: www.franke.com

BXX 210_110 50
Installing document

Sheet	Sheets
9	11

CNC

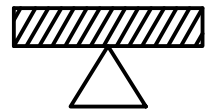

Drawing No.	20119927	Revision	B
Drawn Date	20.03.2015		
<small>These drawings and specifications are the property of Franke Technology and Trademark Ltd. and shall not be reproduced, copied or transferred to any third party without the prior written permission of Franke Technology and Trademark Ltd., Hergiswil, Switzerland</small>			

Franke Küchentechnik AG
CH-4663 Aarburg
Phone: +41 62 787 31 31
Internet: www.franke.com

BXX 210_110 50
Installing document

Sheet	Sheets
10	11

ISO

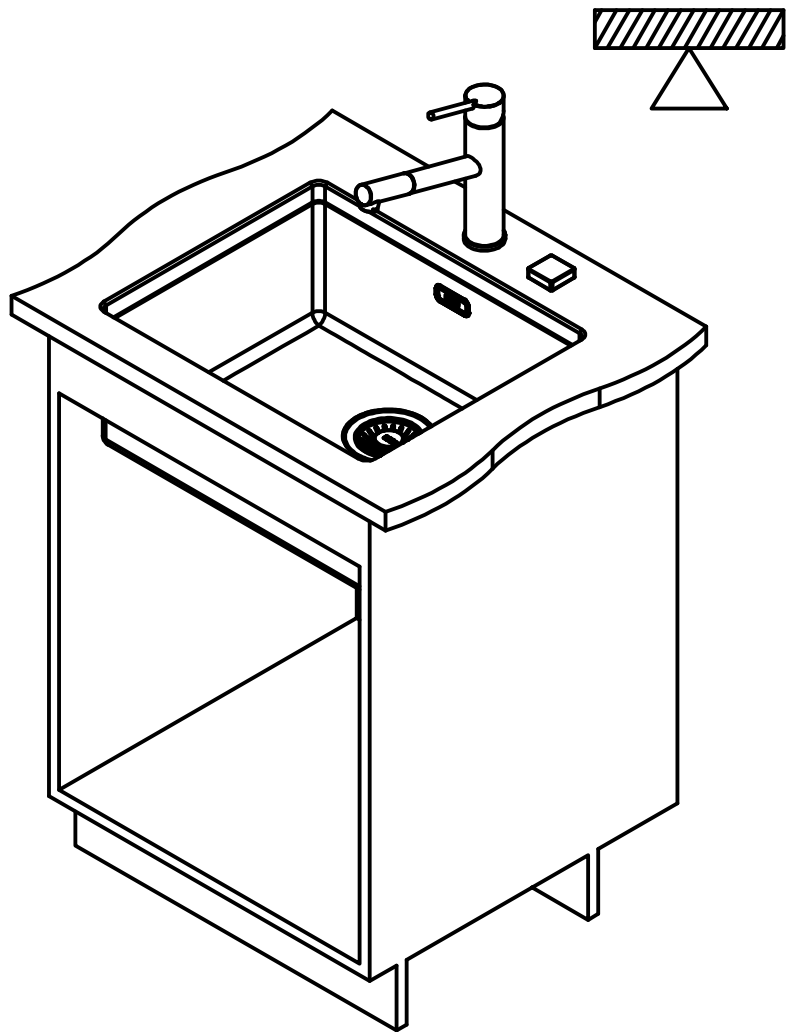

Drawing No.	20119927	Revision	B
Drawn Date	20.03.2015		
<small>These drawings and specifications are the property of Franke Technology and Trademark Ltd. and shall not be reproduced, copied or transferred to any third party without the prior written permission of Franke Technology and Trademark Ltd., Hergiswil, Switzerland</small>			

Franke Küchentechnik AG
CH-4663 Aarburg
Phone: +41 62 787 31 31
Internet: www.franke.com

BXX 210_110 50
Installing document

Sheet	Sheets
11	11