

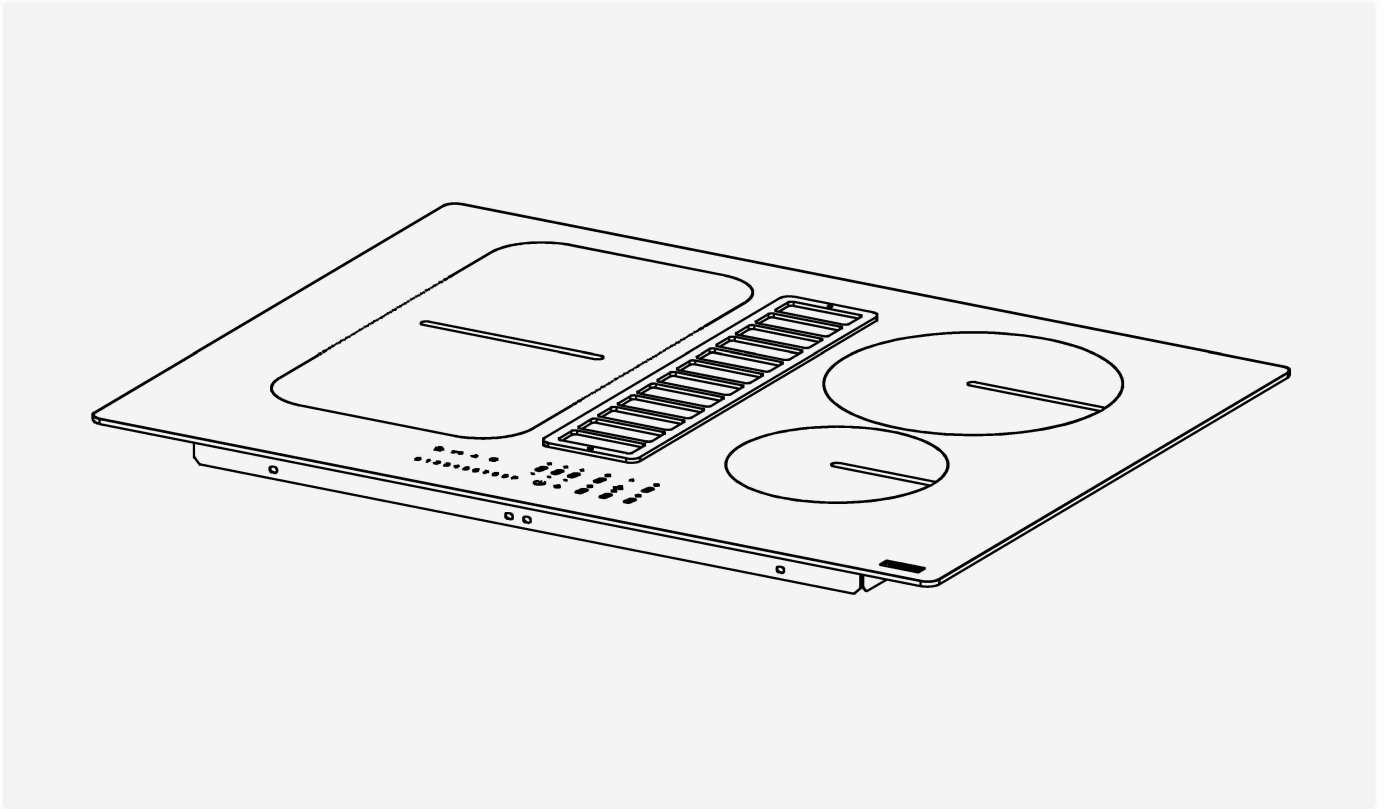

SMART



FSM 709 HI

EN **User manual**

1. SAFETY INFORMATION

 For your own safety and correct operation of the appliance, please read this manual carefully before installation and operation. Always keep these instructions together with the appliance, even if it is sold or transferred to third parties. It is important that users know all the appliance's operating and safety characteristics. These hobs have induction systems that comply with the requirements of EMC standards and with the EMF directive, and they should not interfere with other electronic devices. Pacemaker wearers and those using other electronic implants must consult their doctor or the manufacturer of the implanted device to assess whether or not it is sufficiently resistant to interference.



Electrical connections must be performed by a trained technician. Before making the electrical connection, please read the section on ELECTRICAL CONNECTION.

For appliances with a power supply cable, the terminals or section of wire between the

cable anchor point and the terminals must be laid out that they allow the live wire to be extracted before the earth wire, if it comes loose.

- The manufacturer cannot be held responsible for any damage resulting from incorrect or inadequate installation.
- Check that the mains power supply corresponds to the one indicated on the rating plate affixed to the inside of the product.
- The cut-out devices must be installed in the fixed system according to wiring system regulations.
- For Class I appliances, check that the domestic power supply has a suitable earthing connection.
- Connect the suction hood to the flue using a suitable pipe. Refer to the purchasable accessories indicated in the installation manual (for circular pipes: minimum diameter 120 mm). The length of the discharge piping must be as short as possible.
- Connect the product to the mains using an omnipolar switch.
- The air venting regulations must be complied with.
- Never connect the suction appliance to ducts carrying combustion fumes (heaters, fireplaces, etc.).
- If the suction hood is used alongside non-electrical appliances (e.g. appliances with

gas burners), it is necessary to guarantee a sufficient level of ventilation in the room, to prevent any exhaust back-flow. When the cooking appliance is used together with other appliances using non-electrical power sources, the negative pressure in the room must not exceed 4 Pa, to prevent the fumes being sucked back into the room by the cooking appliance.

- The air must not be discharged into a pipe that is also used as a flue for appliances powered by gas or other fuels.
- If the power cable is damaged, it must be replaced by the manufacturer, an authorised service centre or a qualified technician, to avoid any risk of danger.
- Connect the appliance plug to a socket that complies with current regulations and is in an accessible area.
- As regards the technical and safety measures to be taken for exhausting of fumes, it is important that the regulations set by local authorities be followed carefully.

 **WARNING:** Remove the protective films before installing the appliance.

- Only use the screws and other hardware elements supplied with the appliance.

 **WARNING:** Failure to install the screws or fixing devices as described in these instructions may lead to a risk of electric shocks.

- Cleaning and maintenance must not be carried out by children, unless they are supervised by an adult.
- Children must be supervised to ensure that they do not play with the appliance.
- This appliance must not be used by persons (including children) with limited physical, sensory or mental abilities, or by inexperienced or untrained persons, unless closely supervised and instructed in the safe use of the appliance by a person responsible for their safety.
- This appliance may be used by children over the age of eight and by persons with limited physical, sensory or mental abilities or with insufficient experience and knowledge, provided they are closely supervised and instructed on the safe use of the appliance and on the dangers that it involves. Do not allow children to play with the appliance.

 **WARNING:** The appliance and its accessible parts become extremely hot during use.

Take great care not to touch the heating elements.

Keep children under 8 years of age well away from the appli-

ance, unless they are under constant supervision.

- Clean and/or replace the filters after the period indicated (danger of fire). See the paragraph on Cleaning and maintenance.
- Always guarantee adequate ventilation of the room when the appliance is used in conjunction with other appliances powered by gas or other fuels (this does not apply to appliances that only recirculate the air within the room).

WARNING: If the surface shows any signs of cracking, turn the appliance off to prevent any risk of electric shock.

- Do not turn the device on if the surface is cracked or any damage is visible in the thickness of the material.
- Do not touch the appliance if your hands or body are wet.
- Do not use steam appliances to clean the product.
- Do not rest metal objects such as knives, forks, spoons and pan lids on the surface of the hob, as they might overheat.
- Use the relevant control to turn the hob off after use; do not rely on the pan sensors.

WARNING: Unsupervised cooking on a hob using oil and grease may be dangerous and could cause a fire. NEVER attempt to put flames out with water. Turn the appliance off and suffocate the flames by covering them with a pan lid or a fire blanket, for example.

WARNING: The cooking process must be supervised. A short cooking process must be constantly monitored.

- The appliance is not designed to be started using an external timer or a separate remote controlled system.

WARNING: Danger of fire: do not place objects on the cooking surfaces.

- The appliance must be installed to allow it to be cut off from the electrical power supply with a contact opening (3 mm) that ensures complete disconnection under over-voltage category III conditions.
- The appliance must never be exposed to the elements (rain, sun).
- Ventilation of the appliance must comply with the manufacturer's instructions.
- Keep the packaging away from children and animals.
- Kitchen hoods and other cooking fume extractors can affect the safe operation of appliances which burn gas or other fuels (including those in other rooms) due to the back-flow of combustion gases. These gases can cause carbon monoxide poisoning. After installing a kitchen extractor hood or any other cooking fume extractor, make sure that the gas appliances are tested by a certified technician to guarantee that there

is no backflow of combustion gases.

2. USE

- The suction hood has been designed solely to eliminate cooking fumes during domestic use.
- Never use the appliance for purposes other than those for which it has been designed.
- Deep fryers must be continuously monitored during use: overheated oil could catch fire.
- Do not operate the appliance using an external timer or separate remote controlled system.
- The appliance must never be installed behind a decorative door, to prevent it from overheating.
- Never stand on the appliance, as this may damage it.
- Do not rest hot pots and pans on the frame, as this may damage the silicone seals.
- Do not cut or prepare foodstuffs on the surface and do not drop hard objects onto it. Do not drag pans or plates over the surface.

3. CLEANING AND MAINTENANCE

- Switch the appliance off or disconnect it from the electricity supply before any maintenance work.
- If the Activated Charcoal odour filter is not supplied, follow the instructions provided with the kit for both the regeneration procedure and the replacement times.
- If the Activated Charcoal odour filter is supplied and is of type (U) (refer to the assembly instructions) it can be regenerated. The Activated Charcoal odour filter can be washed and regenerated every 3-4 months (or more frequently if the hood is subject to intensive use), up to a Max. of 8 regeneration cycles (in case of particularly

intensive use it is recommended that you do not exceed 5 cycles). To order a new "U" filter, please contact the assistance service.

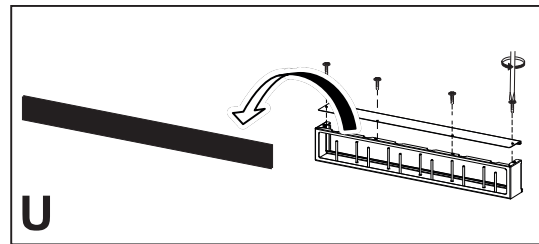

Regeneration procedure:

- Wash in the dishwasher at a MAX temperature of 70° or hand wash in hot water without using abrasive sponges (do not use detergents!).
- Dry in the oven at a MAX temperature of 70° for 2 hours (it is advisable to carefully read the user manual and the assembly instructions of the oven you own).
- The grease filters must be cleaned every 2 months of use, or more frequently in the case of particularly intensive use. They can be washed in a dishwasher. Do not wash the grilles in the dishwasher. (Z).

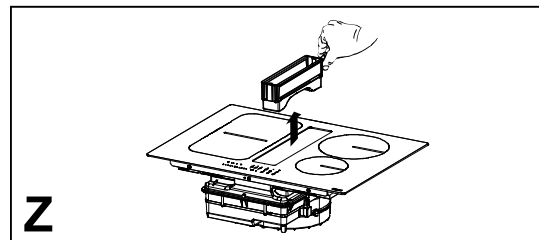

General recommendations

- Never use abrasive sponges, wire wool, hydrochloric acid or other products that might scratch or mark the surface.
- Foods that accidentally fall or settle on the surface, on the functional or aesthetic elements of the hob must not be consumed.

Cleaning the device

- Clean the hob after each use to prevent any food residues from carbonising. It is much harder work to remove encrusted and burnt-on dirt.
- For day-to-day dirt, use a soft cloth or sponge and a suitable detergent.

Follow the manufacturer's recommendations regarding detergents to be used. The use of protective detergents is recommended.

- Remove encrusted dirt, for example milk that has overflowed during boiling, using a scraper pad suitable for vitreous ceramic, while the hob is still hot. Follow the manufacturer's recommendations regarding scraper pads to be used.
- Remove food containing sugar, for example jam that has spilt during cooking, using a scraper pad suitable for vitreous ceramic, while the hob is still hot. If you do not, the residue may damage the vitreous ceramic surface.
- Remove any melted plastic using a scraper pad suitable for vitreous ceramic, while the cooker hob is still hot. If you do not, the residue may damage the vitreous ceramic surface.
- Remove limescale using a small amount of limescale remover solution, for example vinegar or lemon juice, once the cooker hob has cooled down. Then, clean again with a damp cloth.

4. INSTALLATION REQUIREMENTS

The installation process must comply with the laws, ordinances, directives and standards (electrical safety rules and regulations, proper recycling in accordance with the regulations, etc.) in force in the country of use!

- Do not use silicon sealant between the appliance and the worktop. The cooker hob is designed to be fitted flush with the kitchen worktop, on a kitchen unit with a width of 600 mm or more.
- If the appliance is mounted on flammable materials, the guidelines and regulations relating to low voltage installations and fire prevention must be followed strictly.
- For built-in units, the components (plastic materials and veneered

wood) must be mounted with heat-resistant adhesives (min.100°C): the use of unsuitable materials and adhesives can cause deformation and detachment.

- The kitchen unit must have sufficient space to allow for electrical connection of the device. Wall-mounted units above the device must be installed at a sufficient distance to leave the space required to work in comfort.
- The use of decorative hardwood borders around the worktop behind the device is allowed, provided the minimum distance always complies with the indications provided in the installation drawings.
- The minimum distance between the fitted device and the rear wall is indicated in the installation drawing for the flush-fitted device (150 mm for the side wall, 40 mm for the rear wall and 500 mm for any wall-mounted units above it).
- To prevent infiltration of liquids between the edge of the cooker hob and the worktop, fit the adhesive seal supplied along the whole outer edge of the cooker hob prior to installation.

5. ELECTRICAL CONNECTIONS

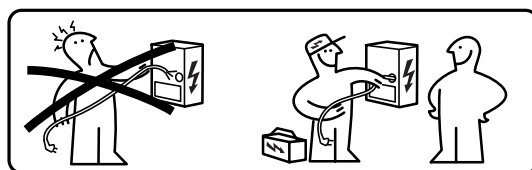

WARNING: All electrical connections must be carried out by an authorised installer.

- Follow the connection diagram (underneath the product).
- This appliance has a Y-type connection. We recommend using an H05V2V2-F power cable measuring 5 x 2.5 mm², SINGLE AND TOW-PHASE connection: minimum wire section: 2.5 mm². External cable diameter: min 8 mm - max 12 mm.

- The connection terminals can be accessed by removing the junction box cover.
- Check that the domestic power supply characteristics (voltage, maximum power and current) are compatible with those of the appliance.
- Connect the appliance as outlined in the installation manual (in compliance with the standard supply voltages in force under national law).

⚠ Attention! Do not weld any of the cables!

6. ENVIRONMENTAL ASPECTS

Disposal of household appliances

The  symbol on the product or packaging indicates that the product must not be disposed of with normal domestic waste. The product must be disposed of at a specialist recycling centre for electrical and electronic components. By ensuring that this product is disposed of correctly, you will help prevent possible negative consequences for the environment and health that might result from its improper disposal. For more detailed information on how to recycle this product, please contact your local municipal offices, local waste disposal service or the shop from which the product was purchased.

The appliance complies with directive 2012/19/EU relating to reduction in the use of dangerous substances in electrical and electronic appliances and waste disposal.

Disposal of packaging materials

Materials with the  symbol can be recycled. Dispose of the packaging in special recycling collection bins.

Energy saving

You can save energy during everyday cooking if you follow hints outlined below.

- When you heat water, only use the quantity you require.
- If it is possible, always put the lids on the cookware.
- Place the pan on the hob before you switch it on.
- Put smaller pans on the smaller cooking areas.
- Put the pans directly in the centre of the cooking area.
- Use residual heat to keep the food warm or melt it.

7. PRODUCT DESCRIPTION

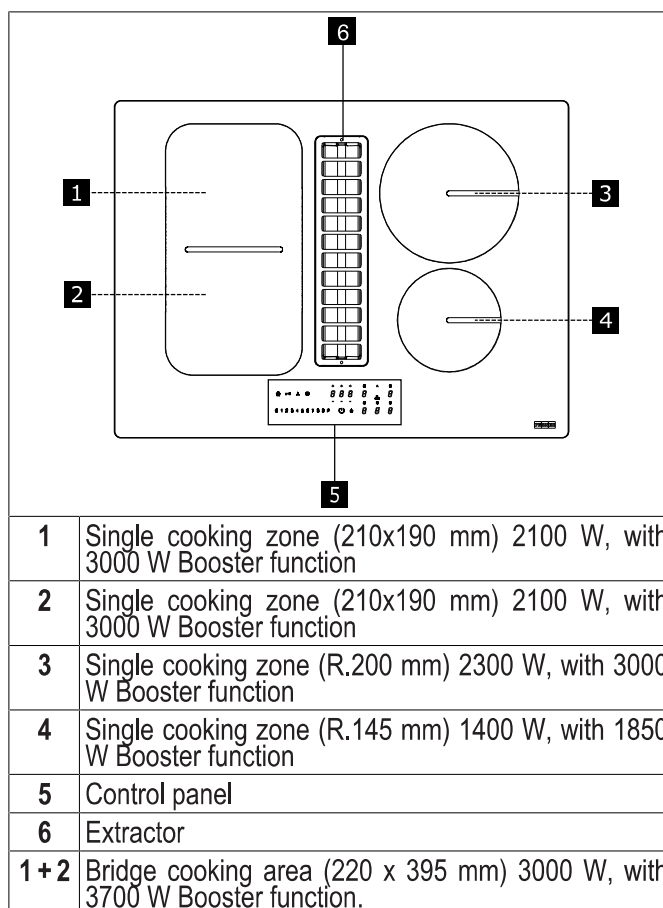

INDICATORS

Pan detection

Each cooking zone is equipped with a system that detects the presence of a pan on the hob.

The detection system is able to recognise pans with a magnetisable bottom of a type suitable for use on induction hobs.

If the pan is removed during operation or an unsuitable pan is used, the symbol  appears on the display.

Residual heat indicator

The residual heat indicator is a safety feature, indicating that the surface of the cooking area is still at a temperature of 50°C or above, which may cause burns if touched with bare hands. The digit for the corresponding cooking area indicates .

8. CONTROL PANEL

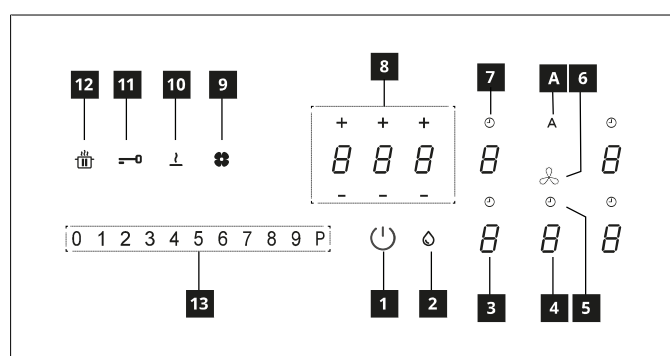

1	On/Off
2	Grease filter saturation indicator
3	Cooking zone power level indicator
4	Extractor power level indicator
5	Extractor timer control
6	Extractor controls zone symbol
7	Cooking zone timer control
8	Timer management zone
9	Activated carbon filter saturation indicator
10	Melting
11	Lock key
12	Pause key
13	Scroll keypad
A	Auto key

The cooking zones can be activated by pressing the reference digit . The digit becomes brighter to confirm the operation.

When a pan is placed on one of the 4 cooking areas, the hob automatically detects its presence and lights up the corresponding digit to activate it.

If there are no pans or other objects on the hob, the digits are not visible.

The functions which can be selected are always visible on the control panel, but with a dimmed light. Select the functions by touching the corresponding symbol.

Turning on the appliance:

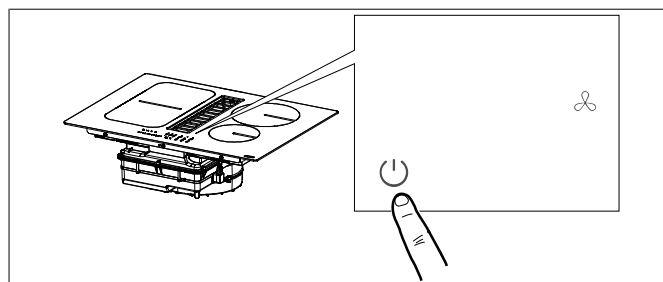

Press and hold the On/Off button for 2 seconds to turn the hob on and activate its functions.

At this point the hob is on but all the cooking zones and the hood are at zero power. The Hob will switch off automatically after 20 seconds if it is not being used.

Warning: For safety reasons the hob can always be turned off using the On/Off button.

Warning: The functions that can be selected will always be the ones that are illuminated/visible on the control panel, and these will always be the only ones that can be activated.

The controls for the cooking areas, suction hood and timer can be activated by pressing on the reference Digit.

The Digit lights up more intensely to confirm the operation.



9. POWER LIMITATION

When connecting to the household power supply for the first time, the installer must set the power of the cooking zones based on the actual capacity of the household power supply.

If this is not necessary, the hob can be turned on directly using , otherwise, follow the operations below to access the menu.

Before carrying out the procedure, it is advisable to read the entire paragraph.

Connect the hob to the domestic mains power.

1. All the digits light up for a few seconds, then switch off and only  keeps flashing.
2. Press and hold : the digits in the cooking area indicate .

3. While holding down , start pressing the zone digits, proceeding anti-clockwise.

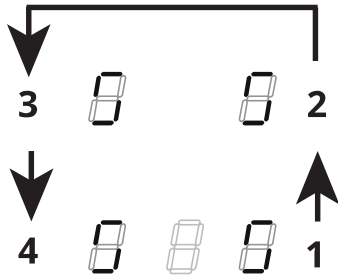

The rear left digit indicates  and a number indicating the type of menu. The front left digit indicates a number which depends on the parameters indicated in the selection.

Select the digit with  and press “8” in the power bar.

Select the front left digit and select the correct setting.

See the following table for the specifications:







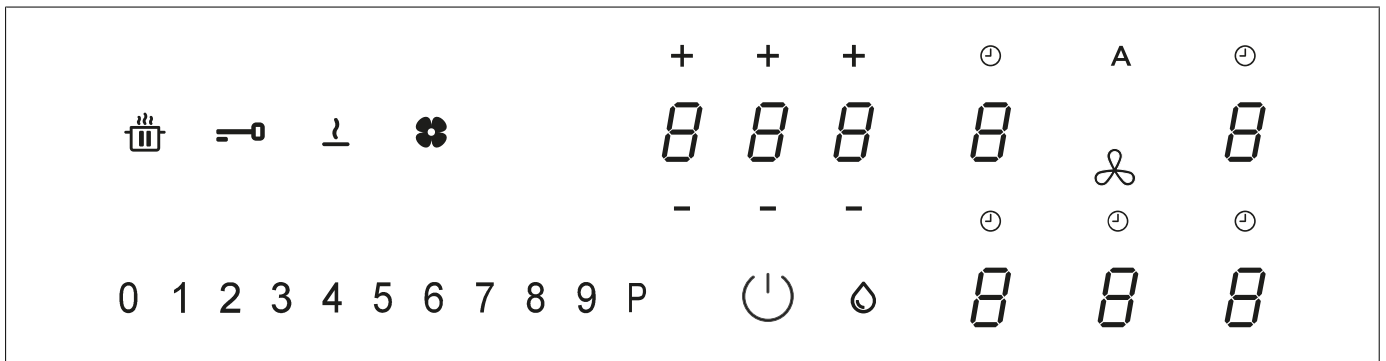





Value on the power bar	KW	Notes
0	7.4	Standard initial setting
1	4.5	
2	3.5	
3	2.8	

Once the correct value has been entered, confirm by touching and holding .

10. HOB FUNCTIONS



<p>Child lock</p>	<p>This function prevents accidental use of the appliance. This cannot be used during a cooking operation</p> <p>To enable: remove all cookware from the appliance, turn the appliance off. If there is no pan on the hob, press and hold for 3 seconds one of the digits (not visible) next to point on the left side. Release and slowly swipe along the power bar from 0 to BOOST. All the digits that indicate . The operations described must be completed within 10 seconds.</p> <p>To disable: turn the appliance on and then press and hold any of the 5 digits for 3 seconds. Release and slowly swipe along the power bar from BOOST to 0. The 5 digit displays will lit up indicating 0 power level. The operations described must be completed within 10 seconds.</p>
<p>Lock</p>	<p>It is possible to lock the hob functions during use, e.g. to clean the hob. The function is enabled even if the hob is switched off and on again. If the electricity supply is cut, the function is disabled.</p> <p>To enable: press and hold for 1 second.</p> <p>To disable: press .</p>
<p>Boost function</p>	<p>Every cooking area can be set to an additional power level for a maximum of 5 minutes.</p> <p>To enable: select one of the 4 cooking areas and select "P" on the power bar. The corresponding digit indicates .</p> <p>To disable: select one of the other possible values on the power bar.</p>
<p>Cooking zone timer</p>	<p>The timer allows a specific cooking area to be switched off when the set time expires. The cooking areas can be programmed individually because each one has its own timer.</p> <p>To enable: With the cooking area in operation, press to access the timer management controls for that zone. The 3 digits indicate "0 0 0". Press "+" or "-" to set the timer countdown.</p> <div style="text-align: center;">  <p>Hours - Tenths - Minutes</p> </div> <p>To confirm the set time, do not touch anything for 10 seconds. When the countdown has finished, the digits are reset and an audible signal is emitted. The function can be interrupted by pressing any key. If the timer is enabled for more than one cooking area, the 3 digits will always show whichever timer is about to finish first.</p> <p>To deactivate: with the cooking area in operation, press to access the timer management controls for that zone. Set the three digits to "0 0 0" using "+" or "-" or press the On/Off key.</p>

Timer (generic)	<p>Timer with alarm for generic use.</p> <p>To enable: switch on the hob making sure there are no pans or active cooking areas. The 3 digits to control the timer show “- - -”. Press the digit to access the timer menu and display “0 0 0”. Press “+” or “-” to set the timer countdown.</p> <div style="text-align: center;">  <p>Hours - Tenths - Minutes</p> </div> <p>To confirm the set time, do not touch anything for 10 seconds. When the countdown has finished, the digits are reset and an audible signal is emitted. The function can be interrupted by pressing any key. Repeat the steps described to change the countdown value.</p> <p>To disable: switch on the hob making sure there are no pans or active cooking areas. Press the digit to access the timer menu and use “+” and “-” to set the display to “0 0 0” “-” or press the On/Off key.</p>																						
Melting	<p>To enable: select one of the 4 cooking zones and press .</p> <p>The digit of the selected zone shows .</p> <p>To disable: press  or press .</p>																						
Heating function	<p>This function is used to heat a pan to the maximum power before continuing to cook at a selected level. The time interval for which the cooking zone is held at maximum power depends on the final cooking level that has been set. See the table:</p> <table border="1" data-bbox="376 842 1485 1263"> <thead> <tr> <th>Power level</th> <th>Timer (seconds)</th> </tr> </thead> <tbody> <tr><td>1</td><td>48</td></tr> <tr><td>2</td><td>144</td></tr> <tr><td>3</td><td>230</td></tr> <tr><td>4</td><td>312</td></tr> <tr><td>5</td><td>408</td></tr> <tr><td>6</td><td>120</td></tr> <tr><td>7</td><td>168</td></tr> <tr><td>8</td><td>216</td></tr> <tr><td>9</td><td>Not available</td></tr> <tr><td>P</td><td>Not available</td></tr> </tbody> </table> <p>To enable, with a pan on the hob and the cooking zone selected, press and hold the selected value (from 1 to 8) on the power bar for 3 seconds. The display of the corresponding cooking zone indicates “A”. The cooking level can be increased, but the function is disabled if it is decreased. It can also be disabled by touching and holding down the key of the cooking zone in question for 3 seconds.</p>	Power level	Timer (seconds)	1	48	2	144	3	230	4	312	5	408	6	120	7	168	8	216	9	Not available	P	Not available
Power level	Timer (seconds)																						
1	48																						
2	144																						
3	230																						
4	312																						
5	408																						
6	120																						
7	168																						
8	216																						
9	Not available																						
P	Not available																						
Pause function	<p>This function allows you to pause/restart any active function on the hob, by reducing the power available in the cooking zone and resetting all the functions. If the Pause function is not disabled with 10 minutes, the hob automatically switches off.</p> <p>To enable: With a pan on the hob and the cooking zone selected, press and hold the Pause function key  for at least 1 second. All the displays show .</p> <p>To disable: press and hold  for 1 second until it starts flashing. Press any other key within 10 seconds. The function is disabled and the hob continues with the previous settings.</p>																						
Recall function	<p>This function is used to recall the function settings of the hob if it is switched off by mistake or the electricity is unexpectedly cut off.</p> <p>When the hob is switched off, if it is switched on again with 6 seconds by touching , the  key flashes for 6 seconds. Press the  key to recall the functions set previously. A beep is emitted to confirm the operation.</p>																						
Combo mode (“bridge” function)	<p>This function allows 2 cooking areas to be combined to use and control them as if they were one and have a bigger cooking area at your disposal. This function allows you to use pans with a wider base. Only the cooking areas on the left and on the right can be selected for use with this function.</p> <p>To enable/disable: press the digits of the left-hand or right-hand cooking zones at the same time to select the 2 areas be combined until the  digit appears to show that the function has been enabled. The other digit is used to set the power level.</p>																						

AUTO function "A"	The standard setting when the hob/suction hood is switched on is for the hood to start up in automatic mode with the LED "A" brightly lit. The Hood comes into operation if the power in the cooking areas is greater than "1". It is deactivated by pressing the LED "A" which changes intensity from bright to dim in confirmation. It can also be deactivated by pressing a value, higher than "1", on the power bar, which is confirmed by the fact that the LED "A" changes intensity from bright to dim. It is reactivated by pressing the LED "A" which changes to brightly lit.
------------------------------	---



11. COOKING TABLE

Power level	Cooking method	To be used for
1	Melting, heating gently	Butter, chocolate, gelatine, sauces
2	Melting, heating gently	Butter, chocolate, gelatine, sauces
3	Warming up	Rice
4	Prolonged cooking, thickening, stewing	Vegetables, potatoes, sauces, fruit, fish
5	Prolonged cooking, thickening, stewing	Vegetables, potatoes, sauces, fruit, fish
6	Prolonged cooking, braising	Pasta, soups, braised meat
7	Light frying	Rösti (potato fry-ups), omelettes, breaded and fried foods, sausages
8	Frying, deep fat frying	Meat, chips
9	Quick frying at high temperature	Steak
P	Quick heating	Boiling water

12. SUCTION HOOD FUNCTIONS



The controls for the cooking areas, suction hood and timer can be activated by pressing on the reference Digit.

"9"	Press "9" on the power bar to set INTENSIVE 1 speed. This setting is timed to operate for 10 minutes. Once this time has passed, the system will automatically return to the speed set previously. It is deactivated by selecting a different speed.
"P"	Press "9" on the power bar twice to set INTENSIVE 2 speed. This setting is timed to operate for 5 minutes. Once this time has passed, the system will automatically return to the speed set previously. It is deactivated by selecting a different speed.
Function Delay	This function is only available if Automatic mode is deactivated. Automatic mode is deactivated by pressing "A". Press the suction hood Digit and set a speed on the power bar. Press the Timer management Digit, which was displaying "CL" but will change to the countdown. This is pre-set to 15 minutes.
	Timer symbol After selecting the suction hood Digit, press the Timer Management Digit to set the countdown.
	Grease filter maintenance symbol The grease filter cleaning signal is displayed by LED and it is always enabled.



Charcoal filter maintenance symbol

The hood is set by default to ducting mode. With no loads on, press the Hood controls digit to enable the suction hood. Press and hold the Digit again for 5 seconds to:

Activate the charcoal filter:

The charcoal (odour) filter symbol lights up for 1 second.

Deactivate the charcoal filter:

The charcoal (odour) filter symbol flashes twice.

After activation, the icon will light up to indicate that maintenance must be carried out on the charcoal (odour) filter.

Reset and reactivation of the charcoal filter







After having carried out maintenance on the filter:

press and hold for 5 seconds. - The LED of the grease filter will turn off and the countdown will restart.

press and hold for 5 seconds. - The LED of the anti-odour filter will turn off and the countdown will restart.

13. USER MENU CUSTOMISATION

Before carrying out the procedure, it is advisable to read the entire paragraph.

- Press .
- Press again and hold  for 3 seconds.
- The  key starts flashing.
- Press and hold : the digits in the cooking area indicate .
- Hold  and start pressing the digit of the cooking areas in clockwise order starting from the left front one.

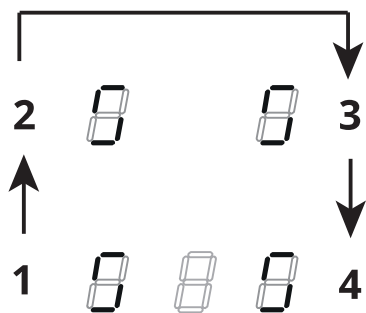

The rear left digit alternately indicates  and a number from 2 to 7 indicating the menu code.

The front left digit indicates a number which depends on the parameters indicated in the selection.

- Press the left rear digit.
- Select a number on the power bar to access the menu code.
- Press the left front digit.
- Select a number on the power bar to select a value.

See the following table for the specifications:

Menu code	Description	Value
U2	Key sound volume control menu.	0 - Sound disabled 1 - Min. 3 - Max.
U3	Countdown beeper volume control menu.	0 - Sound disabled 1 - Min. 3 - Max.
U4	Display brightness level control menu.	0 - Max. 9 - Min.
U5	Countdown display control menu.	0 - Countdown display disabled 1 - Countdown display enabled
U6	Pan detection menu.	0 - Enabled 1 - Disabled
U7	Countdown end management menu.	0 - Continuous flashing and shut-down 1 - Ten flashes and shut-down 2 - One flash and shut-down

- Once the correct value has been entered, confirm by touching and holding  for 2 seconds.

- To exit the menu without saving, press .

If no operation is carried out the user menu will close after 1 minute.

14. POWER MANAGEMENT FUNCTION

This product has an electronically controlled power management function.

This function controls the delivery of the maximum power of 3700 W between the combined cooking areas (left side and right side), optimising the power distribution and avoiding system overload situations.

To do this, the total power is monitored continuously, and reduced when necessary. If it is not possible to supply the total power required, a control element reduces by a predefined amount the power in another cooking element so that it is at a level immediately below its respective power curve. This ensures that the current absorption of 16 A is not exceeded.

In this case the generator detects the last command with the highest priority sent by the user interface and, if necessary, reduces the previous settings activated for another cooking element.

The Power management function is first activated when the presence of a pan is detected on the cooking element.

Example:



If boost level (P) is selected for hob 1, hob 2 cannot exceed level 9 at the same time and will be automatically limited.”

15. GUIDE TO PAN USE

Which pans to use

Only use pots and pans with the bottom made from ferromagnetic material which are suitable for use with induction hobs:

- cast iron
- enamelled steel
- carbon steel
- stainless steel (including partial)
- aluminium with ferromagnetic coating or ferromagnetic plate

To determine if a  or pan is suitable, check for the  symbol (usually stamped on the bottom). You can also hold a magnet to the bottom. If it clings to the underside, the pan can be used on an induction hob.

To ensure optimum efficiency, always use pots and pans with a flat bottom that distributes the heat evenly. If the bottom is not perfectly flat, this will affect power and heat conduction.

How to use

Minimum diameter of pot/pan base for the different cooking areas.

To ensure that the hob functions properly, the pan must cover one or more of the reference points indicated on the surface of the hob, and must be of a suitable minimum diameter.

Always use the hob that best corresponds to the diameter of the bottom of the pan.

Cooking areas	Pan base diameter	
	Ø min.(recommended)	Ø max (recommended)
Combined left	190 mm	230 mm
Single left	110 mm	190 mm
Single front right	110 mm	145 mm
Single rear right	110 mm	200 mm

Empty pots/pans or with thin base

Do not use empty or thin-based pots/pans on the hob as it will be unable to detect the temperature or turn off automatically if the temperature is too high,

thus damaging the pan or the hob surface.

If this occurs, do not touch anything and wait for all components to cool down.

If an error message appears, refer to “Troubleshooting”.

Normal working noises in the hob

Induction technology is based on the creation of electromagnetic fields. These electromagnetic fields generate heat directly on the bottom of the pan. Pots and pans may produce a variety of noises or vibrations, according to their construction.

These types of noise can be described as follows:

Light buzz (like the noise made by a transformer)

This noise is produced when cooking with a high level of heat, and it is determined by the amount of energy transferred by the hob to the pans. The noise will stop or decrease when the heat level is reduced.

Light whistle

This noise is produced when the pot or pan is empty, and stops as soon as it is filled with water or food.

Crackle

This noise occurs with pans made from layers of numerous different materials, and is caused by vibration of the surfaces where the different materials meet. The noise comes from the pans, and may vary according to the quantity of food and preparation method being used.

Loud whistle

This noise occurs with pans made up of layers of different materials, and also when these are used at maximum level and on two cooking areas. The noise will stop or decrease when the heat level is reduced.

Fan noises

For the electronic system to operate correctly, the temperature of the cooker hob must be regulated. To do this, the hob is equipped with a cooling fan that is

activated to reduce and regulate the temperature in the electronic system. The fan may continue to operate after the appliance has been turned off, if the temperature of the cooker hob is still detected to be too high.

Rhythmic sounds like a clock ticking

This noise only occurs when at least three cooking areas are operating, and it disappears or decreases when some of them are turned off.

The noises described are a normal feature of induction technology and are not to be considered as defects.

16. TROUBLESHOOTING

Error code	Description	Possible causes of the error	Solution
“Acoustic signal upon ignition. No error code displayed”	The hood command does not work	LIN cable damaged or badly connected to the hood electronic board	check connection/replace the LIN cable
ER03	Hob switches off after 10 sec.	Continuous key activation detected. Water or pan placed on the control panel.	Remove water or pan from the ceramic glass surface and control panel.
ER21	Hob switches off.	The internal temperature of electronic parts is too high.	Let the hob cool down. Please check if the hob has sufficient ventilation. If the error persists, please contact After Sales Service.
E2	Corresponding cooking area switches off.	Empty or unsuitable pan. Pan or ceramic glass surface temperature too high. Electronic component temperature too high.	Let the hob cool down. Use a suitable pan. Do not heat empty pans.
E3	Corresponding cooking area switches off.	Unsuitable pan. The pan is losing its magnetic properties and may damage the induction hob.	Use a suitable pan. The error is automatically cancelled after 8 seconds and the cooking area can be used again. If any other errors occur, the pan must be changed. If the error persists, please contact After Sales Service.
E6	Hob does not switch on.	Power supply voltage and/or frequency is out of range.	Check mains voltage and/or frequency. If necessary, contact After Sales Service.
E8	Cooking areas are turned off.	Fan fault. Fan blocked by dust or fibres.	Clean and remove foreign bodies from the fan. If the error persists, please contact After Sales Service.
E4 E5 E7 E9 ER20 ER22 ER31 ER36 ER42 ER47 EA EH	Disconnect the hob from the power supply. Wait a few seconds, then reconnect the hob to the power supply. If the problem persists, call the After Sales Service and specify the error code that appears on the display.		

17. MAINTENANCE - REPAIR AND CONFORMITY

- Make sure that maintenance on electrical components is only carried out by the manufacturer or by the service technicians.
- Make sure that damaged cables are only replaced by the manufacturer or by the service technicians.

When contacting the service department, please provide the following information:

- Type of fault
- Device model (Art./Cod.)
- Serial number (S.N.)

This information can be found on the identification plate. The identification plate is affixed to the bottom of the device.

Information on the product pursuant to EU regulation no. 66/2014

Reference standards:

EN/IEC 60350-2

EN/IEC 50564



This appliance has been designed, manufactured and sold in compliance with EEC Directives.

18. TECHNICAL DATA

Product identification

Type: **4300**

Model: FSM 709 HI

Model: FSM 709 HI LL KIT

Please see the identification plate affixed to the bottom of the product.

The manufacturer makes continual improvements to products. For this reason, the text and illustrations in these instructions for use may change without warning.

Further information on the technical data is available on the website: www.franke.com

MODEL	FSM 709 HI
	FSM 709 HI LL KIT
Total maximum power (hob and hood)	7.62 Kw (basic setting)
Total maximum power (hob and hood)	4.72 Kw
Total maximum power (hob and hood)	3.72 Kw
Total maximum power (hob and hood)	3.02 Kw

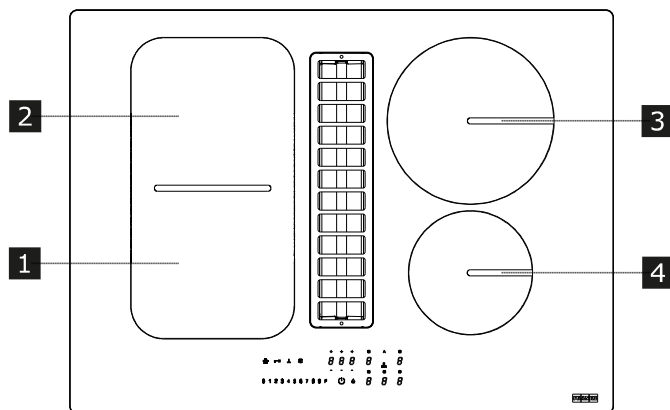

1,2 Flexible cooking area 1 + 2 In bridge
3,4 Flexible cooking area

Parameter	Value	Dimensions (mm)
Working dimensions	-	700 × 520 (W x D)
Power supply voltage/frequency	220-240 V, 50 Hz; 220 V, 60 Hz 2N~ 380-415 V, 50 Hz; 2N~ 380 V, 60 Hz	
Electrical and heating element data		
Cooking area 1,2	2100 W; Power Boost: 3000 W	210 x 190
Cooking area 3	2300 W; Power Boost: 3000 W	R 200
Cooking area 4	1400 W; Power Boost: 1850 W	R 145
Flexible cooking area 1+2	3000 W; Power Boost: 3700 W	210 x 390
Parameter	Value	Dimensions (mm)
Weight of the device	21	kg
Number of cooking areas	4	
Heat source	induction	

www.franke.com

Franke UK Ltd.
MIOC, Suite 1, Styal Road
Manchester
M22 5WB
www.franke.com/gb/en/hs.html

