

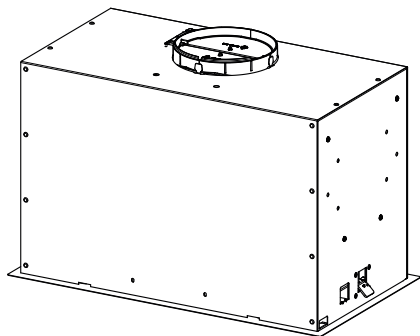

EN USER MANUAL



1. SAFETY INFORMATION

 For your own safety and to ensure proper operation of the appliance, please read this manual carefully before installation and operation. Keep these instructions together with the appliance, even if it is sold or transferred to third parties. It is important that users know all the appliance's operating and safety characteristics.

 The cables must be connected by a trained technician.

- The manufacturer shall not be considered responsible for any injury or damage caused by improper installation or use.
- The minimum safety distance between the hob and the suction hood is 650 mm (some models may be fitted at a lower height; please see the paragraph relating to working dimensions and installation).
- If the instructions for installation of the gas hob specify a distance greater than the one indicated, this must be taken into account.
- Check that the mains power supply corresponds to the one indicated on the data plate affixed inside the hood.
- The cut-out devices must be installed in the fixed system according to wiring system regulations.
- For Class I appliances, check that the domestic power supply is adequately earthed.
- Connect the hood to the flue using a pipe with a minimum diameter of 120 mm. The fumes must travel the shortest distance possible.
- All the air venting regulations must be complied with.
- Do not connect the ducting hood to flues that also carry combustion fumes (e.g. boilers, chimneys, etc.).
- If the hood is used in combination with non electric appliances (e.g. gas appliances), a sufficient level of ventilation must be guaranteed in the room to prevent any exhaust backflow. If the kitchen hood is used in combination with appliances that are not electrically powered, the negative pressure in the room must not exceed 0.04 mbar to avoid any risk of the fumes being sucked back into the room by the hood.
- The air must not be extracted through a flue that is also used as an exhaust flue for fumes from gas or other fuel powered combustion devices.
- If it is damaged, the power cable must be replaced by the manufacturer or by a service technician.
- Connect the plug to a socket that complies with current regulations and is in an accessible position.

- As regards the technical and safety measures to be taken for exhausting of fumes, it is important that the regulations set by local authorities be complied with scrupulously.

 **CAUTION:** remove the protective films before installing the hood.

- Only use screws and hardware of a sort suitable for the hood.

 **CAUTION:** failure to install the screws or fixing devices as described in these instructions may mean there is a risk of electric shocks.

- Do not look directly at the light through optical devices (binoculars, magnifying glasses...).
- Do not flambé food under the hood: you might cause a fire.
- This appliance may be used by children over the age of 8 years and by persons with limited psycho-physical and sensory abilities or with insufficient experience and knowledge, provided they are carefully supervised and instructed on how to use the appliance safely and on the dangers that it involves. Make sure that children are not allowed to play with the appliance. Cleaning and maintenance to be performed by the user must not be carried out by children, unless they are under supervision.
- Supervise children, to make

sure they do not play with the appliance.

- The appliance must not be used by persons (including children) with limited psycho-physical or sensory capacities or with insufficient experience and knowledge, unless they are carefully supervised and instructed.

 Accessible parts may become extremely hot during the use of cooking appliances

- Clean and/or replace the filters after the period of time indicated (danger of fire). See the paragraph on Maintenance and cleaning.
- The room must be adequately ventilated when the hood is used simultaneously with appliances that use gas or other fuels (not applicable to appliances that only discharge air into the room).
- The symbol  on the product or on its packaging indicates that the product must not be disposed of with the normal domestic waste. The product must be disposed of at a specialist re-cycling centre for electrical and electronic components. By making sure that this product is disposed of properly, you will help prevent possible negative consequences for the environment and for health that might result from its improper disposal. For more detailed information on how to re-cycle

this product, please contact your local municipal offices, local waste disposal service or the shop in which the product was purchased.

2. USE

- The suction hood has been designed exclusively for domestic use, to eliminate kitchen odours.
- Never use the hood for purposes other than those for which it was designed.
- Never leave high flames under the hood when it is in operation.
- Adjust the intensity of the flame so that it is directed onto the bottom of the cooking pan, making sure it does not wrap around the sides.
- Deep-fryers must be kept under constant supervision when in use: the oil may catch fire if it gets too hot.

3. CLEANING AND MAINTENANCE

- The activated charcoal filter cannot be washed or regenerated, and must be changed approximately every 4 months of operation, or more frequently in the case of particularly intensive use (W).

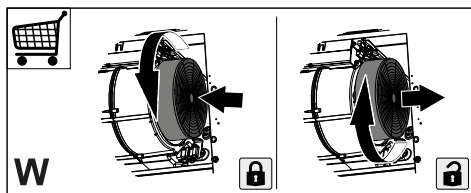

- The grease filters must be cleaned every 2 months of operation, or more frequently in the case of particularly intensive use. They can be washed in a dishwasher (Z).

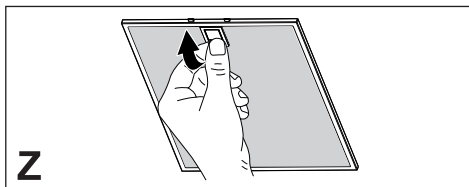

- Clean the hood using a damp cloth and neutral liquid detergent.
- Avoid using alcohol or silicone-based products to clean the inside and outside of the cooker hood.

4. CONTROLS

Key	Key press	Function	LED
T1	Short	Turns off the motor.	-
T2	Short	Turns the motor on at the first speed.	The keys T1 and T2 are on.
T3	Short	Turns the motor on at the second speed.	The keys T1 and T3 are on.
T4	Short	Turns the motor on at the third speed.	The keys T1 and T4 are on.
	Long	Turns the motor on at the Intensive speed. This speed is timed for 6 minutes. At the end of this time, the system automatically returns to the previously selected speed. If activated with the motor off, once the time has passed it switches to OFF mode. It is deactivated by pressing the same key or by switching off the motor.	Flashes.
L	Short	Switches the lighting system on and off to maximum brightness.	On.

5. LIGHTING

- Please contact the Service Department to change it ("Please contact the service department to purchase it").



Franke UK Ltd.
MIOC, Suite 1, Styal Road
Manchester
M22 5WB
www.franke.com/gb/en/hs.html