









# MARIS

## GRANITE 33" DOUBLE BOWL SINK MAG6201515-S

### TECHNICAL FEATURES

Overall Sink Size (OD)	33" x 22"
Equal Bowl Size (ID)	15 <sup>3</sup> / <sub>16</sub> " x 16 <sup>1</sup> / <sub>16</sub> "
Bowl Depth (ID)	9 <sup>1</sup> / <sub>2</sub> "
Corner Radius	16mm
Minimum Cabinet Size	36"
Installation Type	Topmount
Weight	43 lbs.
Warranty	Limited Lifetime

### AVAILABLE FINISHES

 Champagne MAG6201515-CHA-S 114.0687.127	 Onyx MAG6201515-ONY-S 114.0687.130
 Stone Grey MAG6201515-SHG-S 114.0687.133	 Oyster MAG6201515-OYS-S 114.0687.131
 Polar White MAG6201515-PWT-S 114.0687.132	 Matte Black MAG6201515-MBK-S 114.0687.128
 Mocha MAG6201515-MOC-S 114.0687.129	 Slate Grey <b>NEW</b> MAG6201515-SLG-S 114.0713.095

### INCLUDED ACCESSORIES

Strainer  
1145  
112.0266.494

### OPTIONAL ACCESSORIES

Bottom Grid MA-15-36S 112.0687.993	Roller Mat MA2-31RM 112.0080.355	Colander PX-70S 112.0066.060
Cutting Board MA2-40S 112.0688.102	Drain Cover RNDCVR 112.0532.169	Colorline Cover RNDCVR-XXX (xxx represents color)
Colorline Strainer 900-XXX (xxx represents color)	Colorline Flange WD-900-XXX (xxx represents color)	

Product Image



Dimensional Drawing

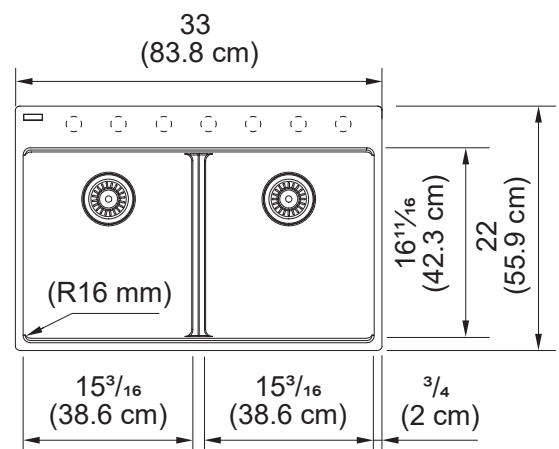

7 pre-scored holes for faucet and accessories

